

THIS DRAWING IS UNPUBLISHED. RELEASED FOR PUBLICATION  
 © COPYRIGHT - BY TYCO ELECTRONICS CORPORATION. ALL RIGHTS RESERVED.

LOC	DIST	REVISIONS					
H	-	P	LTR	DESCRIPTION	DATE	DWN	APVD
		A		DRAWING RELEASED PER ECR-11-017294	22AUG2011	JvdH	TdB

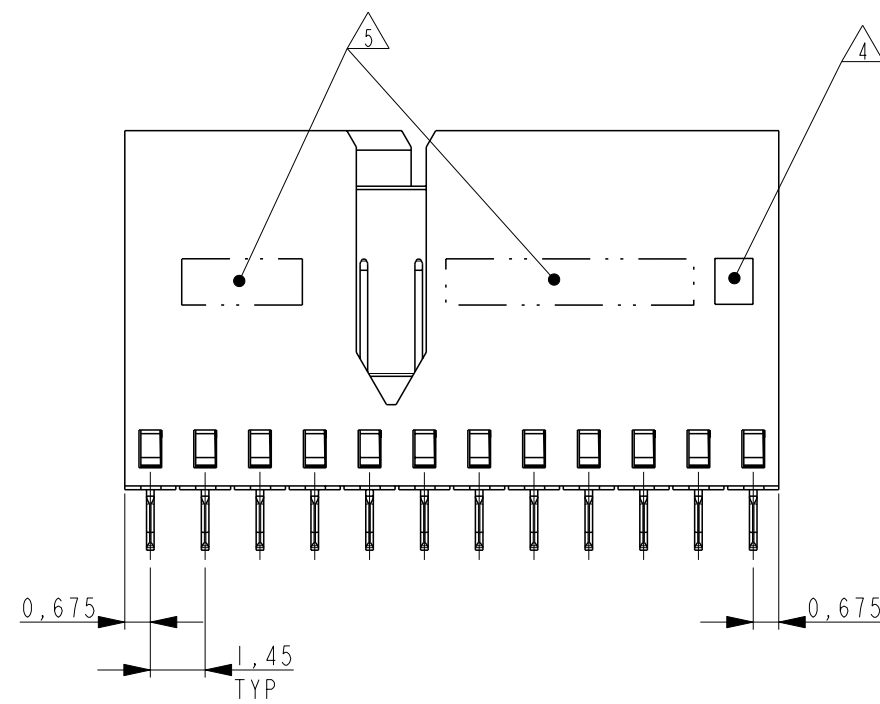
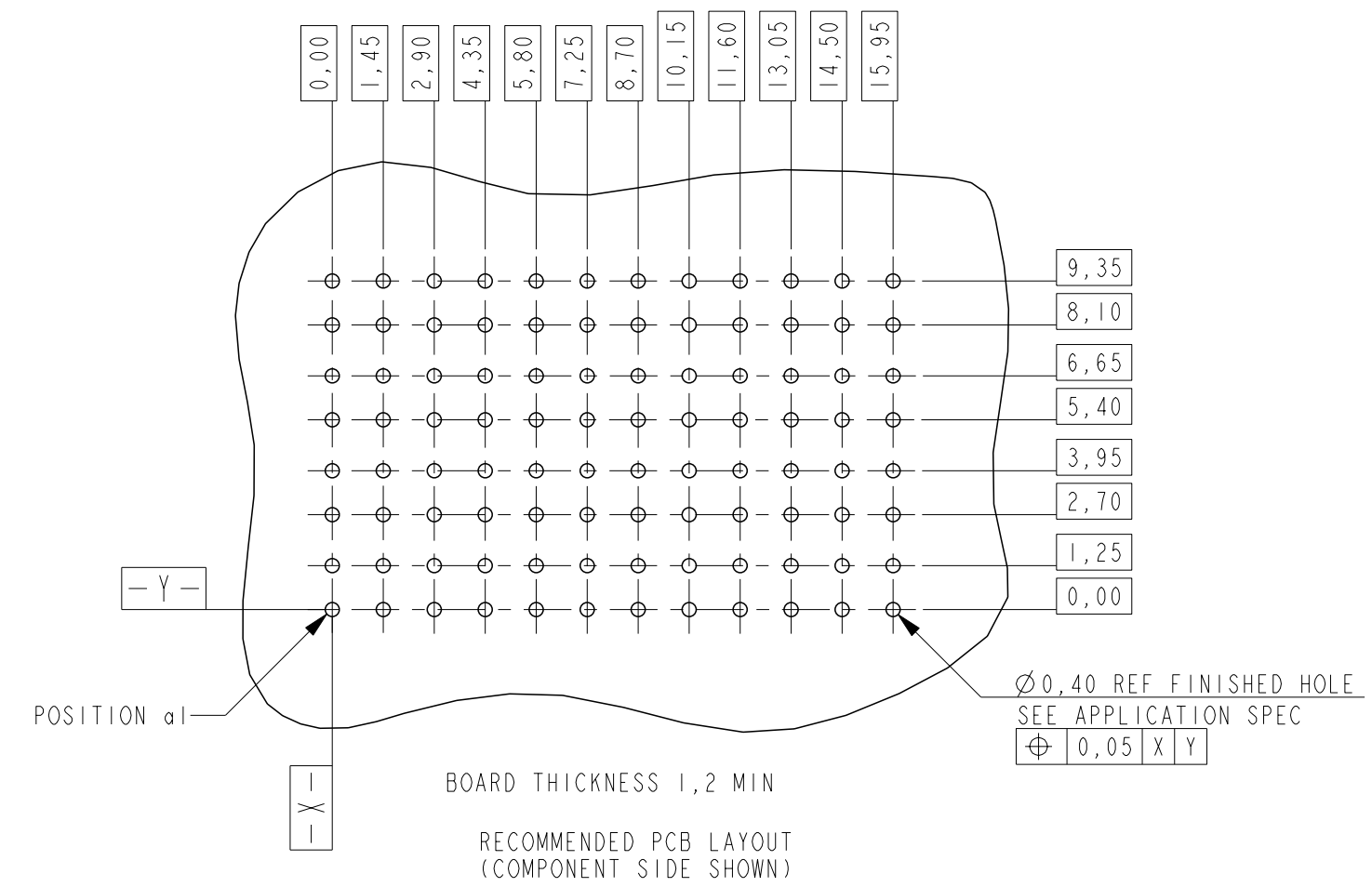
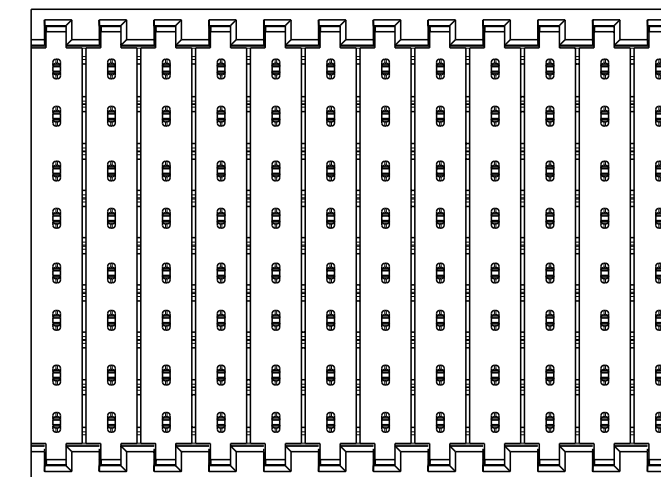
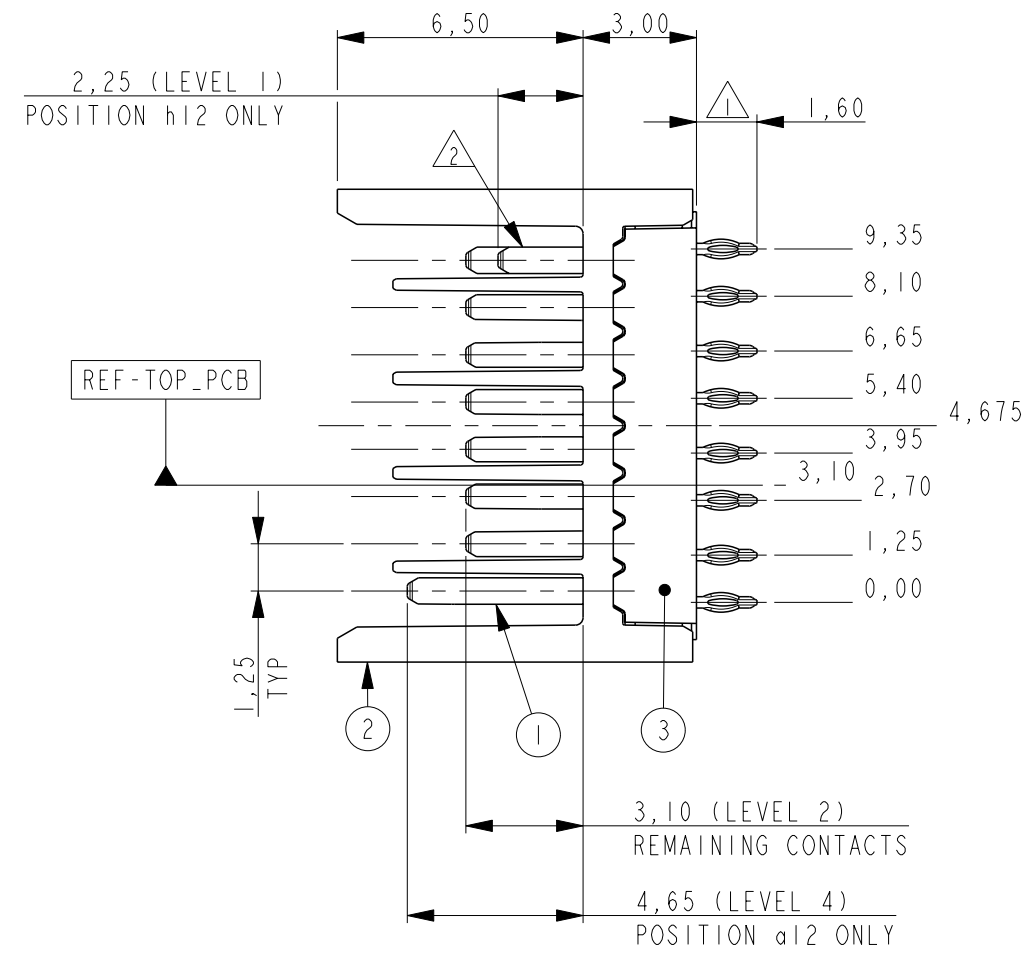
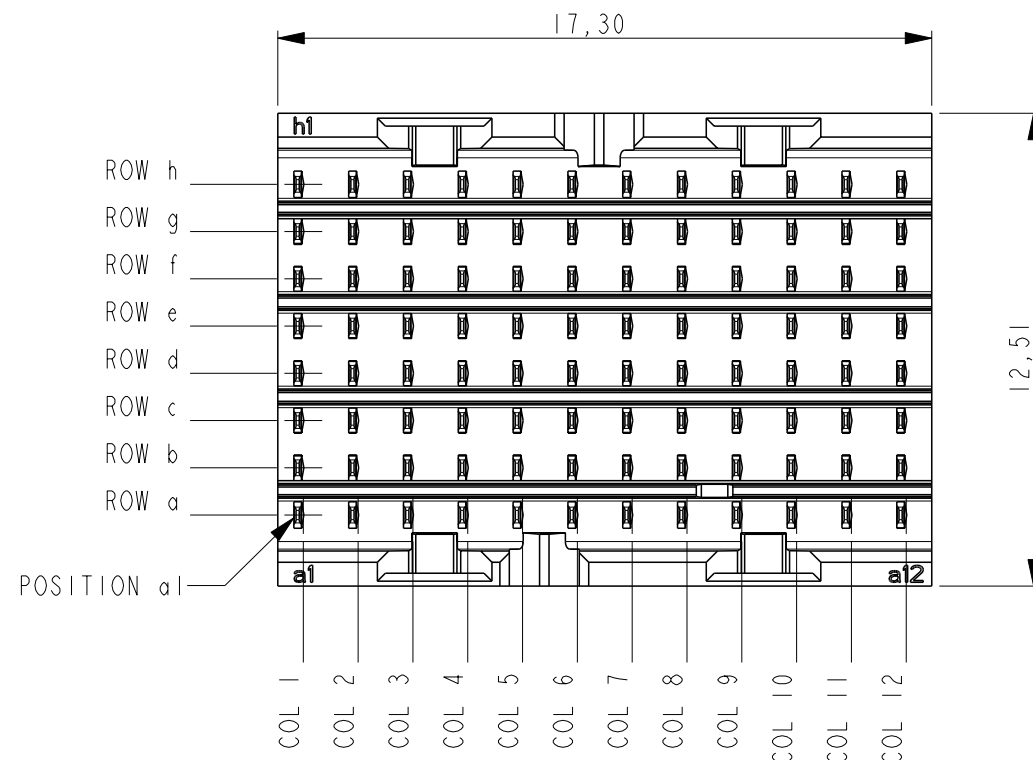
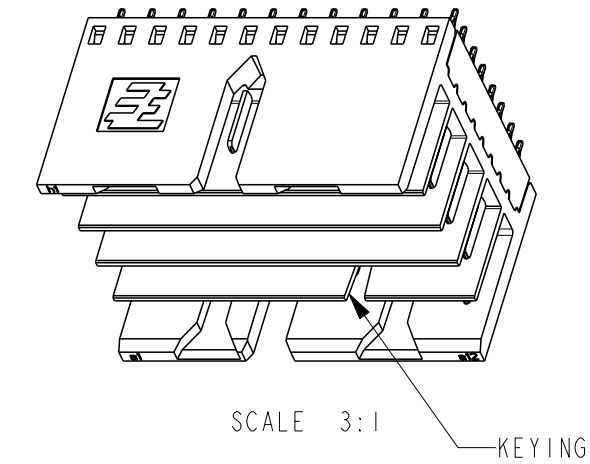
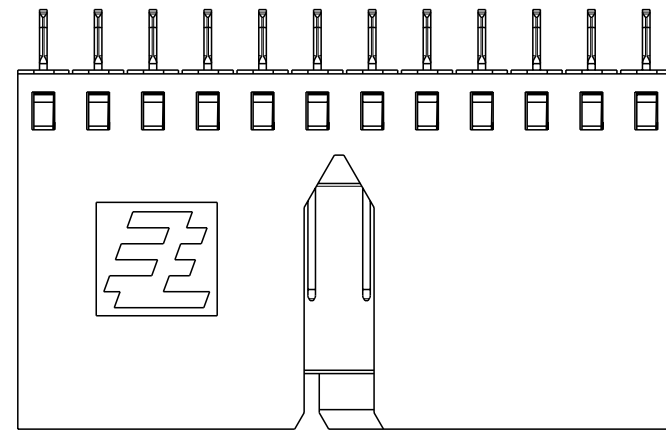

NOTES:

- △ PLATING: 0,5µm MIN. TIN OVER NICKEL.
- △ PLATING:

PARTNUMBER	PERFORMANCE LEVEL
1551099-1	PERFORMANCE LEVEL 1: CONNECTOR TESTED AND QUALIFIED AGAINST TELCORDIA GR-1217-CORE QUALITY LEVEL III: UNCONTROLLED ENVIRONMENT APPLICATIONS. SEE PRODUCT SPEC 108-19353
1551099-2	PERFORMANCE LEVEL 2: CONFORMS TO ALL TESTING ACCORDING PRODUCT SPEC 108-19320, -250 MATING CYCLES, 4 DAYS MIXED GAS TEST PER IEC 60068-2-60 METHOD I

- 3 CONSULT APPLICATION SPEC OR CONTACT TE CONNECTIVITY FOR PERMISSIBLE CONTACT ASSIGNMENTS.
- △ BLACK SQUARE MARKING FOR LEVEL 4 PIN AT POSITION a12 AS INDICATED.
- △ CONNECTOR MARKED WITH PARTNUMBER AND DATE CODE.
- 6 FOR PC-BOARD ROUTING RECOMMENDATIONS SEE SPEC 114-19140

**PRODUCT HAS NOT COMPLETED QUALIFICATION TESTING**

THIS DRAWING IS A CONTROLLED DOCUMENT.

DIMENSIONS:	TOLERANCES UNLESS OTHERWISE SPECIFIED:
mm	0 PLC ±
	1 PLC ±
	2 PLC ±
	3 PLC ±
	4 PLC ±
	ANGLES ±
	FINISH ±

DWN Vahsa 09-Feb-2009  
 CHK R Annokkee 09-Feb-2009  
 APVD Mark Westen 09-Feb-2009  
 PRODUCT SPEC SEE NOTE 2  
 APPLICATION SPEC 114-19106  
 WEIGHT -  
 CUSTOMER DRAWING

3	OVERMOLD	LCP 30% GF NATURAL
2	HOUSING	LCP 30% GF NATURAL
1	CONTACT	COPPER ALLOY
ITEM NO.	DESCRIPTION	MATERIAL



NAME MALE CONNECTOR Z-PACK Slim UHD

SIZE	CAGE CODE	DRAWING NO	RESTRICTED TO
A2	00779	C-1551099	-

SCALE 5:1 SHEET 1 OF 1 REV A