

IRU3065 EVALUATION BOARD USER GUIDE

INTRODUCTION

The IRU3065 controller is designed to provide solutions for the applications requiring low power on board switching regulators. The IRU3065 is specifically designed for positive to negative conversion and uses few components for a simple solution. The IRU3065 operates at high switching frequency (up to 1.5MHz), resulting in smaller components. The output voltage can be set by using an external resistor divider. The stability over all conditions is inherent with this architecture without any compensation. The device is available in the standard 6-Pin SOT-23.

(see the IRU3065 data sheet for detailed description).

SPECIFICATION DATA

Inputs:

- JP1: Optional VDD input. Default VDD is connected to VCC through a charge pump.
- JP2: Optional Vref input. If accurate output is required, Vref should be connected to a accurate reference voltage
- JP4: 5V Bus input and Vcc input (default connection). The output voltage will be equal to input voltage with negative sign.

Outputs:

- JP3. Vout=-5V @200mA.

Switching frequency

Fs(MAX)=1.2 MHz

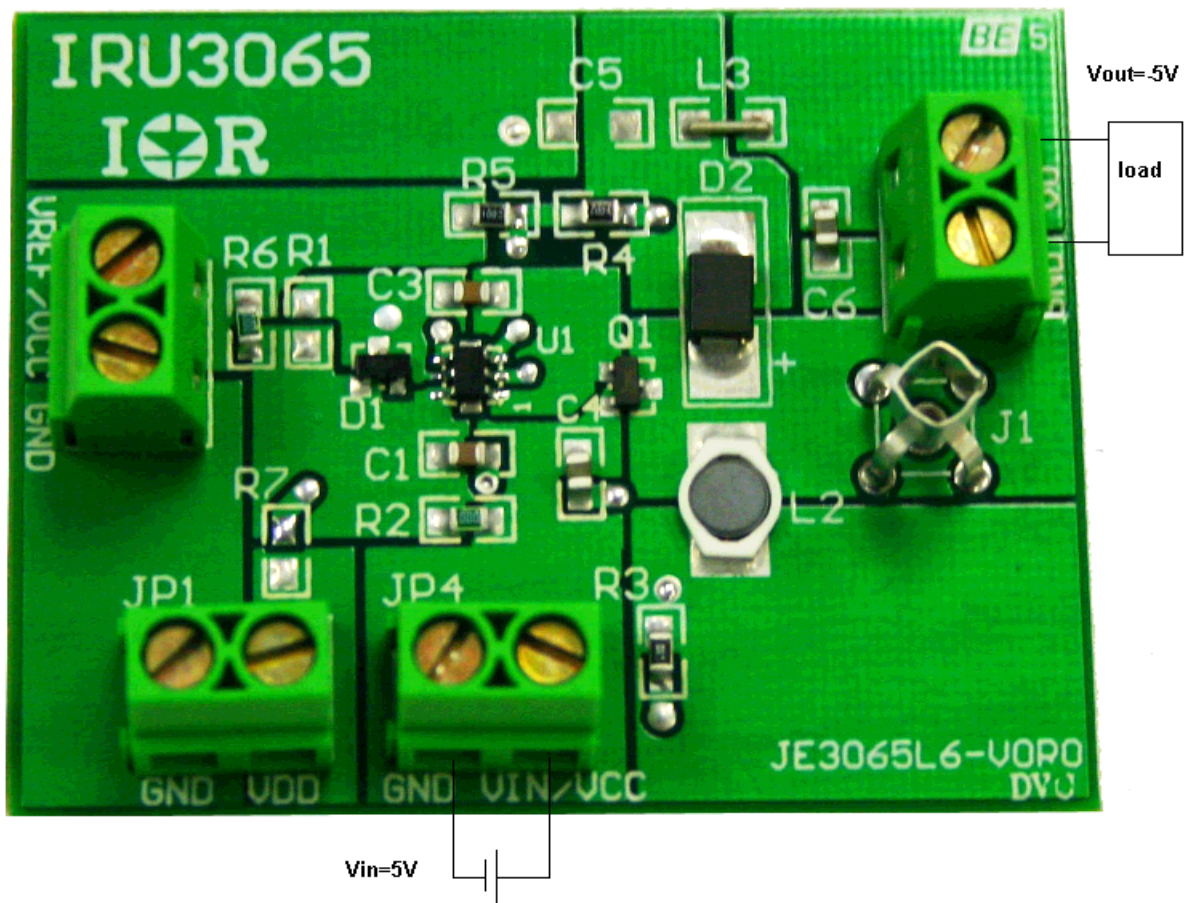

SCHEMATIC

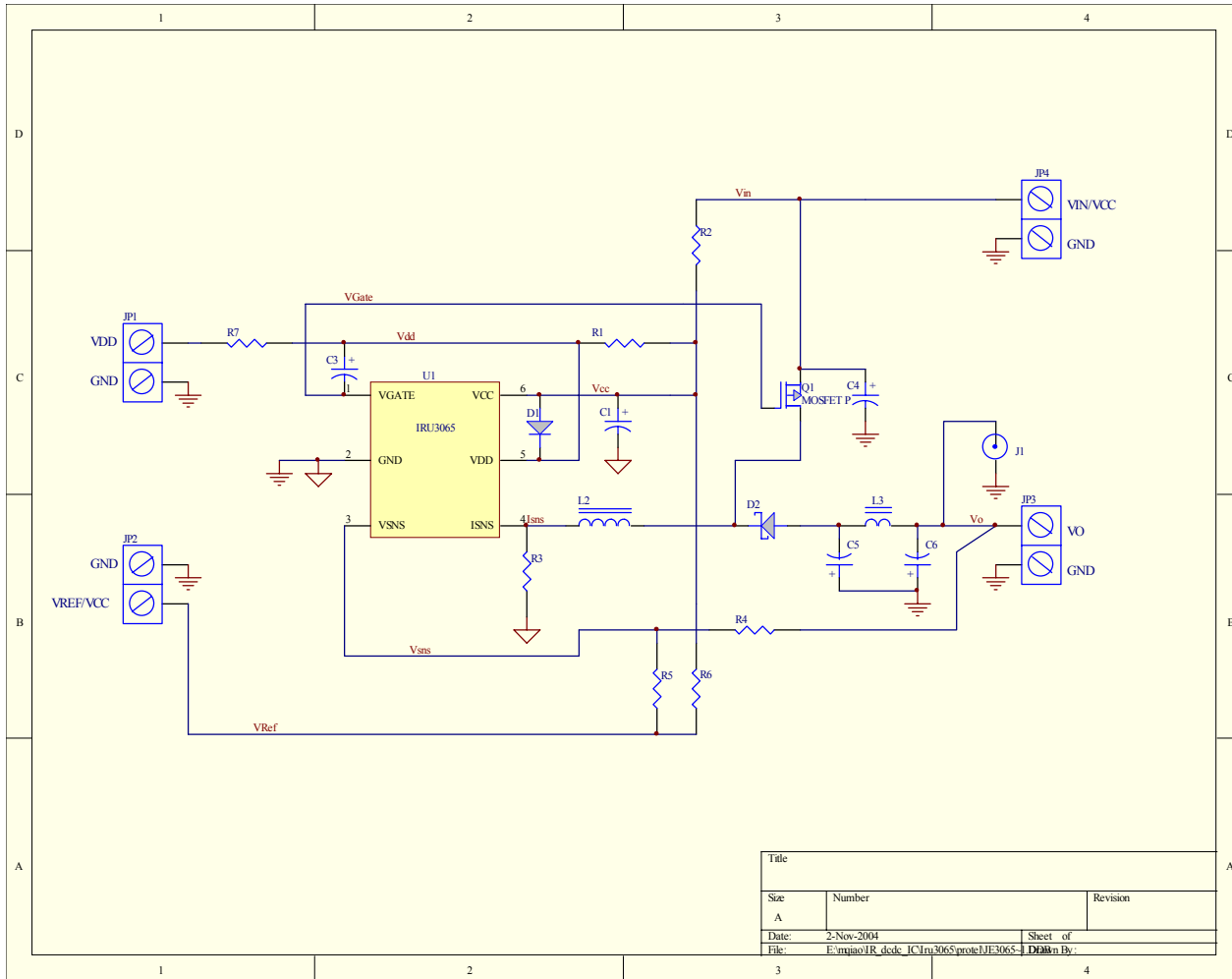
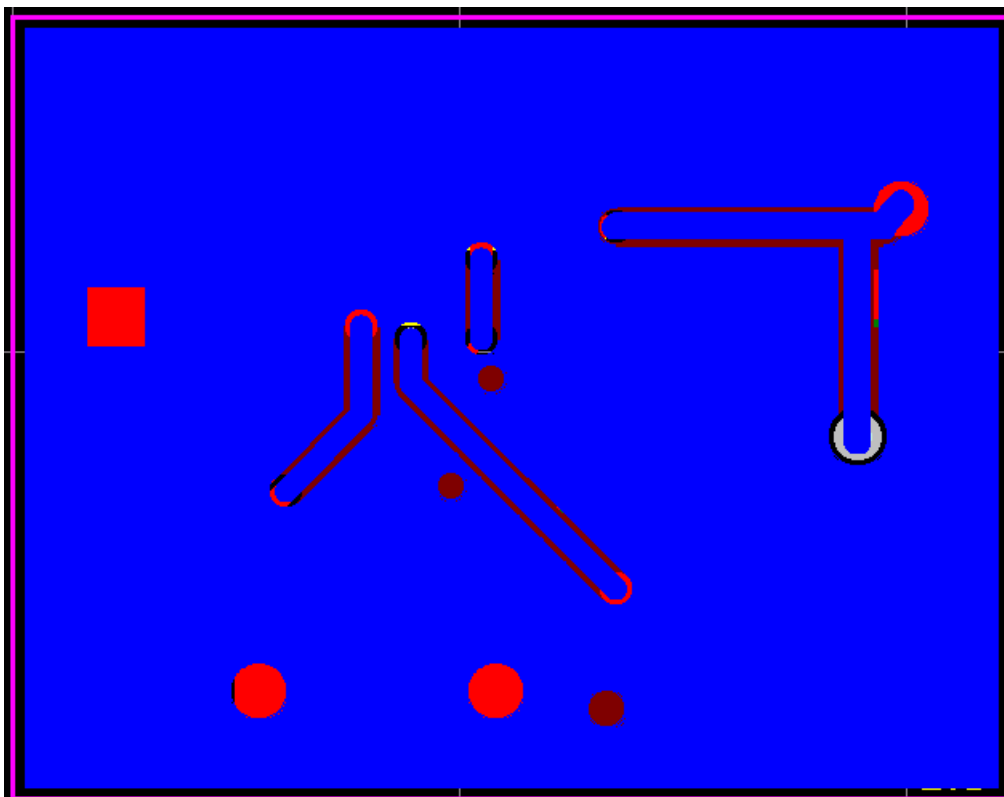
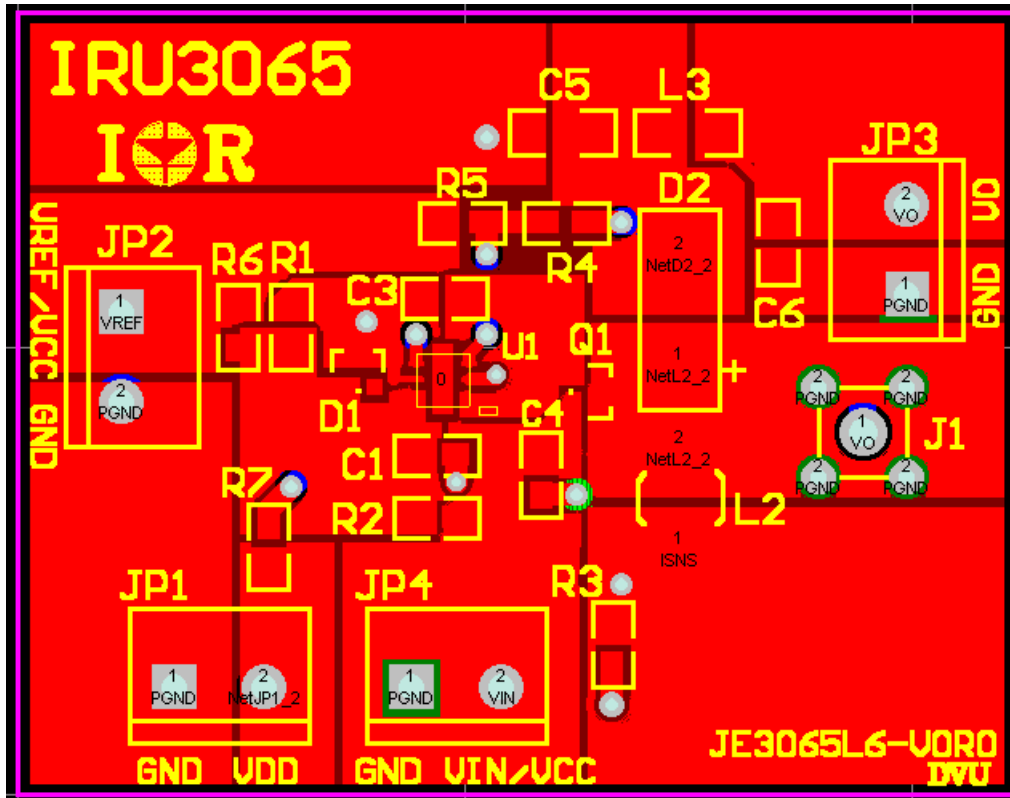

Figure 1 - Schematic of IRU3065 evaluation-board.

Bill of Material (BOM)

Ref Designator	Description	Value	Qty	Part#	Manuf
Q1	MOSFET	PFET	1	IRLML5203	IR
U1	Controller		1	IRU3065	IR
D1	Diode	Fast Switchinh	1	BAT54	IR
D2	Diode	Fast Switchinh	1	10BQ015	IR
L2	Inductor	1.2uA, 2A	1	LPO1704-122MC	Coilcraft
C1	Ceramic Cap	1uF, Y5V,16V	1	ECJ-2VF1C105Z	Panasonic
C3	Ceramic Cap	100pF, X7R,50V	1	ECJ-2VC1H100J	Panasonic
C6,C4	Ceramic Cap	10uF, X5R, 6.3V	2	ECJ2FBOJ106M	Panasonic
R4, R5	Resistor	10K, 1%, 0805	2	Any	Any
R3	Resistor	0.1Ohm, 0805	1	Any	Any
R1,R7	Resistor	Open	2		
R2,R6	Resistor	Short	2		
L3	Inductor	Short	1		
C5	Ceramic Cap	Open	1		
JP1,2,3,4	Terminal		4	ED1973-ND	Digi-Key
J1	Scope Probe		1	S1012-02-ND	Digi-Key
Bumpon			4		3M

Layout-Top layer and Bottom layer



Operation Characteristics

Efficiency versus load current

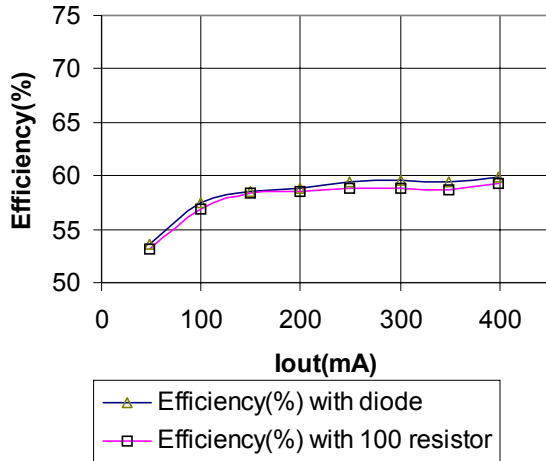

Efficiency with 1.2uH inductor, 800k Hz operation

Vout(V) vs Iout(mA)

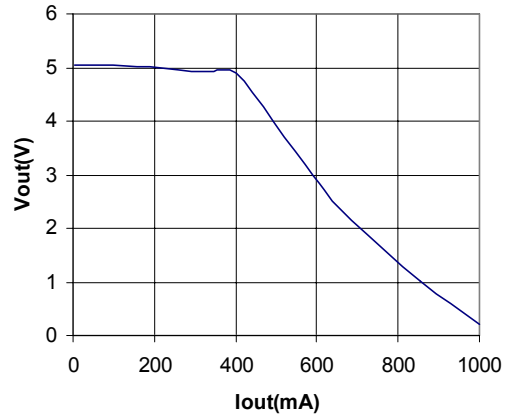

Output voltage (absoutle value) versus load curren (Vout=-5V, Iocp=400mA)t

Efficiency versus load current

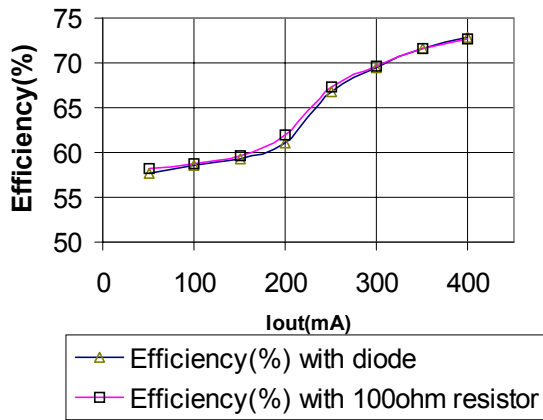

Efficiency with 4.7uH inductor, 250kHz operation

Frequency (KHz) versus load current

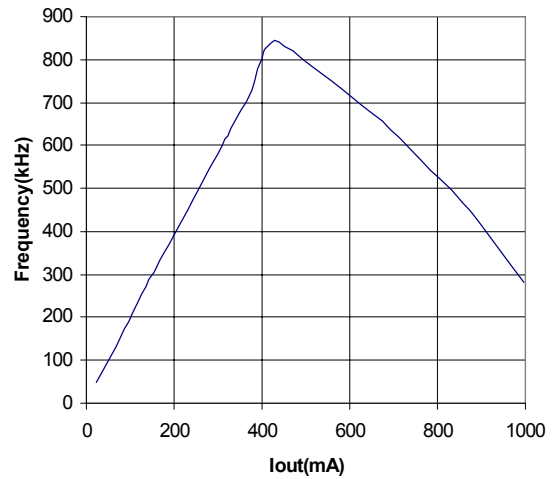

Frequency versus load current. (Vout=-5V, Iocp=400mA)t

Experimental waveforms

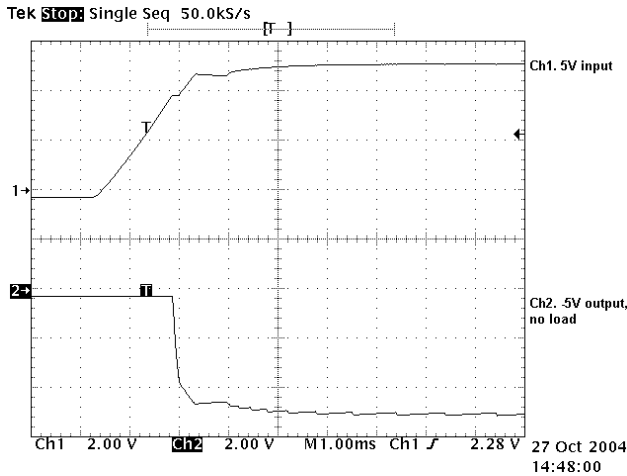

Start Up

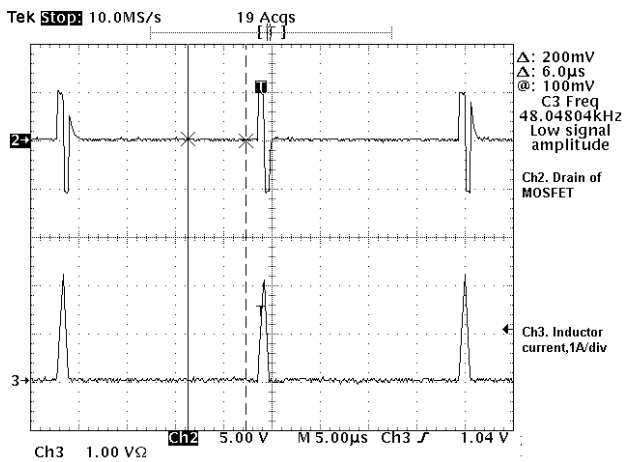

Operation waveform at 20mA load.

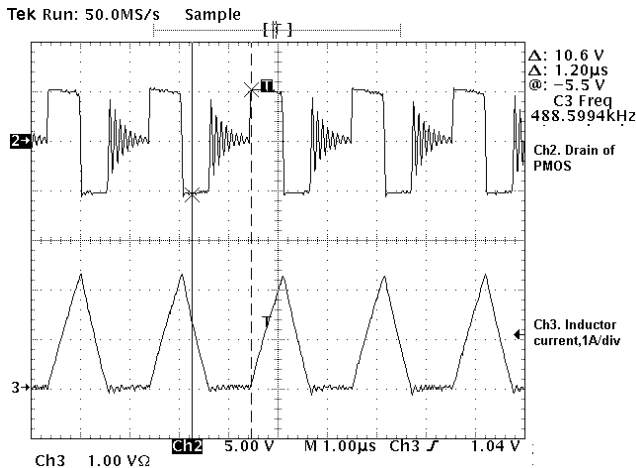

Operation waveforms with 250mA load (normal operation)

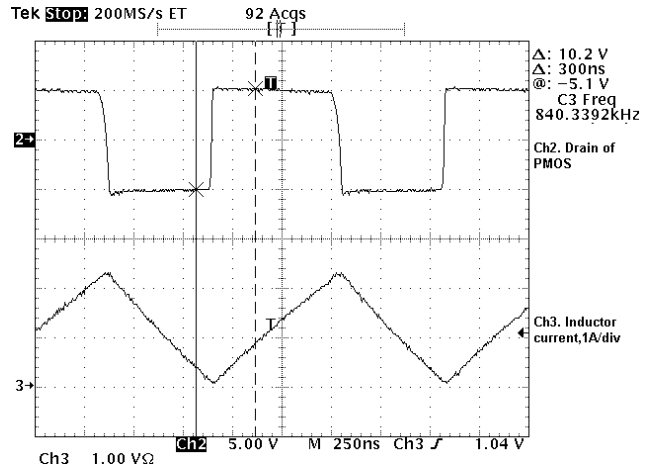

Operation waveform with 450mA, the boundary of continuous mode and discontinuous mode. The output start out of regulation

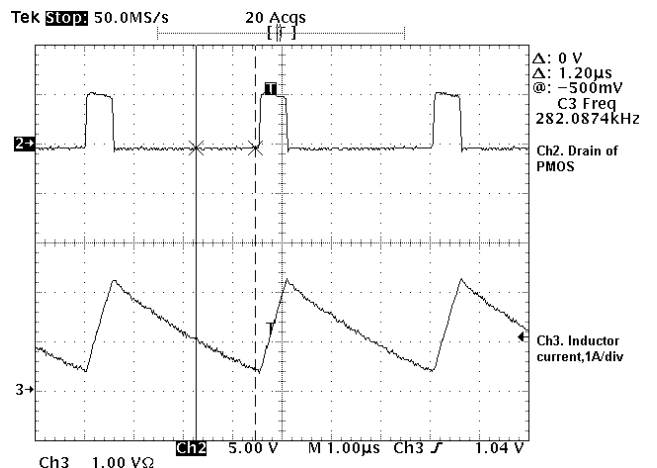

Operation waveform with short output.

