

USER MANUAL

LDX-U20

12/24 V 20 A High Performance DC-UPS

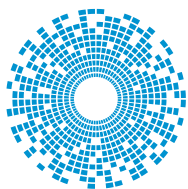

bel POWER SOLUTIONS & PROTECTION

a bel group

belfuse.com/power-solutions

CONTENTS

1	System description	4
2	Features and benefits	5
3	Functional description	6
3.1	Remote monitoring and controlling	6
3.1.1	USB	6
3.1.2	Digital input	6
3.1.3	Dry contact outputs	6
3.2	Backup	7
3.3	PC shutdown and automatic restart	7
3.4	Battery health monitor	9
3.5	Battery resistance measurement	9
3.6	Battery charger	10
3.7	Coulomb counter	11
3.8	Cold start	11
4	Installation	12
4.1	Connecting the input to the power supply	12
4.2	Connecting the load	12
4.3	Connecting the battery	12
4.4	Connecting the temperature sensor	12
4.5	Connecting the INHIBIT input	12
4.6	Dry contacts	13
4.7	Battery sense connection	13
5	User interface	14
5.1	Status	15
5.2	Settings	16
5.2.1	Input nominal voltage	16
5.2.2	Battery chemistry	16
5.2.3	Battery nominal voltage	16
5.2.4	Battery capacity	16
5.2.5	Battery charge voltage	16
5.2.6	Battery charge current	16
5.2.7	Battery deep discharge voltage	17
5.2.8	Battery low voltage	17
5.2.9	Battery nominal internal resistance	17
5.2.10	Battery maximal internal resistance variation	17
5.2.11	Battery maximum temperature	17
5.2.12	Battery minimum temperature	17
5.2.13	Battery lifetime	17
5.2.14	Maximum backup time	18
5.2.15	Inhibit polarity	18
5.2.16	Screen contrast	18
5.2.17	Screen backlight	18
5.2.18	Screen timeout	18
5.2.19	Buzzer state	18
5.2.20	Date	18
5.2.21	Time	19
5.2.22	PC shutdown enable	19
5.2.23	PC shutdown delay	19
5.2.24	PC shutdown time	19
5.2.25	PC restart minimum OFF time	19
5.2.26	PC OFF detection current threshold	19
5.2.27	PC OFF detection timer	19
5.2.28	Relay 1 (Ready)	20
5.2.29	Relay 2 (Backup)	20

5.3	Info	20
5.3.1	Firmware version	20
5.3.2	Serial	20
5.3.3	Name	20
5.3.4	Power ON cycles counter	20
5.3.5	Operating time	21
5.3.6	Battery installation date	21
5.3.7	Battery operating time	21
5.4	Logs	21
5.5	Wizard	21
6	Events and Alarms	22
7	Physical dimensions	25

1 SYSTEM DESCRIPTION

Use latest device Documentation, Software and Firmware to ensure reliable operation of the system (downloadable from belfuse.com/power-solutions).

The LDX-U20 is a microprocessor controlled DC UPS rated 20A (rating of the power supply connectable to the input) usable in systems with a nominal voltage between 12V and 28V.

The LDX-U20 monitors the voltage coming from a DC power supply and in case of power failure a backup battery is connected to the load. In normal condition the battery is kept charged by an integrated battery charger supporting various battery chemistries such Lead-Acid, NiMH, NiCd and Lithium.

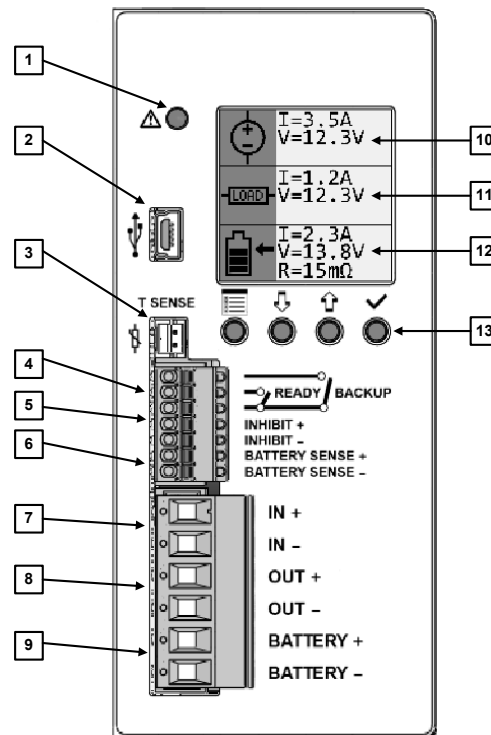

Figure 1. Front panel view

1. **Alarm LED Indicator:** It is ON when the unit is in backup. It blinks at 1Hz rate in case of error.
2. **USB Port:** Used to connect a PC running the POWERMASTER application for remote monitoring and controlling. Firmware update is also possible through USB connection.
3. **Temperature Sensor Connection:** Used to connect a temperature sensor (P/N: WNTC-2MT) to measure the battery temperature for protection and temperature compensated charge method.
4. **Relays Dry Contacts:** 2 relays are present for remote monitoring. See §3.1 for more details.
5. **Inhibit Input:** A signal between 5VDC and 30VDC applied to this input inhibits the backup function; this input is programmable to be active high or active low (see §4.5).
6. **“Battery sense” Connection:** Used to accurately sense the battery voltage by considering the cables voltage drop. It is recommended to use this input when the battery internal resistance measurement is needed (see §4.7).
7. **Input Connection:** 2 poles are provided for input connection. This must be connected to a power supply rated 12...28VDC with a maximum rated current of 20A (see §4.2).
8. **Output Connection:** 2 poles are provided for output connection. It must be connected to the load to be backed up with a maximum rated current of 20A (see §4.2).
9. **Battery Connection:** 2 poles are provided for battery connection. This must be connected to the battery. Although the unit is protected, please respect the correct polarity. (see §4.3)
10. **Display “Input” Area:** provides information regarding the unit’s input (see §5.1).
11. **Display “Output” Area:** provides information regarding the unit’s output (see §5.1).
12. **Display “Battery” Area:** provides information regarding the battery (see §5.1).
13. **Control Keys:** 4 push buttons are provided to navigate through the menus and to select the various functions.

2 FEATURES AND BENEFITS

The Main Features are:

- Integrated battery charger for multi-chemistry batteries with charging current up to 5A.
- Automatic sensing of input voltage, load current and battery current.
- Protections against battery reverse polarity connection and over current when operating from the battery.
- Battery “health monitoring” system: measuring battery internal resistance, battery temperature and providing a Coulomb counter.
- User settable maximum backup time.
- Remote input to inhibit the UPS function.
- Connection of a battery thermal sensor (optional).
- Integrated data logger with time stamp: all events / errors are logged in the internal memory and downloadable through the USB interface.
- Automatic PC shutdown/restart function (see §3.3)

Embedded User Interface:

- 4 buttons and 1 color graphic CSTN LCD, Displays the set-up, status, measures and alarms
- Online device configuration.
- USB port for remote monitoring and configuration.
- Dry contacts for status monitoring

“POWERMASTER” PC Application:

- Connection through USB interface.
- Remote monitoring and configuration.
- Firmware upgrade.
- Same functionalities of the embedded user interface with the ease of the PC benefits.

3 FUNCTIONAL DESCRIPTION

A simplified block diagram of the LDX-U20 is shown in Figure 2.

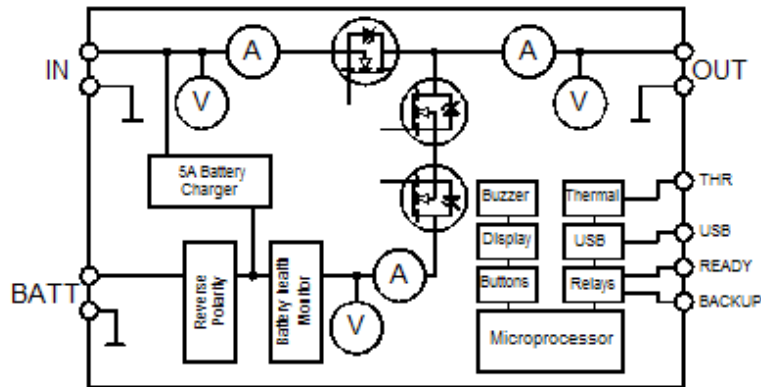

Figure 2. LDX-U20 simplified block diagram

LDX-U20 is a high performance digitally controlled DC-UPS that can be used in any DC system with a rated voltage between 12V and 28V and up to 20A of input current.

It includes a battery charger capable of charging Lead-Acid, Ni-MH and Li-ION batteries with a rated voltage between 12V and 28V and able to deliver a charge current up to 5A.

The input voltage is continuously monitored by the microprocessor. In case of a power outage the battery is connected to the load instantaneously through an active switch, reducing the power loss to a minimum.

The product offers additional features to improve the performance and the reliability of the system, which are described below.

3.1 REMOTE MONITORING AND CONTROLLING

3.1.1 USB

The USB interface allows the communication with the proprietary POWERMASTER software (available for download at www.nextys.com) which allows the full control and monitoring of the LDX-U20 unit with the ease of the PC.

3.1.2 DIGITAL INPUT

An opto-isolated input allows the inhibition of the backup function. The polarity of the input can be defined using the Inhibit polarity setting (see §5.2.15).

3.1.3 DRY CONTACT OUTPUTS

2 relays are present on the LDX-U20. User can chose which event activates the relay and the polarity. The list of events is the following:

NAME	DESCRIPTION	DEFAULT SETTING
Backup	Active when the system is running on the batteries.	Relay 2
SoC < 25% (Low Battery)	Active when the State of Charge (SoC) of the battery is below 25%.	Unused
Battery life time expired	Active when the battery life time counter is exceeding the value specified on §5.2.13	Relay 1
Battery Ri too high	Active when the measured battery internal resistance (Ri) > alarm threshold. The threshold is specified using setting §5.2.9 and §5.2.10.	Relay 1
Battery failure	Active when the battery could not be charged correctly.	Relay 1
Battery under voltage	Active when the battery voltage is below the value specified on §5.2.7	Unused
Battery backup time left < 25%	Active when the remaining backup time is higher than the 75% of the maximal backup time defined on §5.2.14	Unused
PC OFF signal	Activated by the PC shutdown and automatic restart function. See §3.3 for details.	Unused

Table 1. Relays signals

By default both relays polarity is set to NC (Normal Close).

3.2 BACKUP

The system is in backup if the supply for the output is sourced from the battery (input supply missing). During backup the battery is monitored continuously to prevent over discharge (see §5.2.7).

A programmable backup timer (see §5.2.14) is also implemented in order to fix a maximum backup time during power outages. This allows preserving the battery life and shortening the recharge time, avoiding discharging the battery when not needed.

During backup the internal Coulomb counter is used to give an estimation of the residual charge of the battery, this information is given to the user on the LCD in form of remaining % and through the ready relay which starts toggling at 1Hz once the battery charge is < 20%.

3.3 PC SHUTDOWN AND AUTOMATIC RESTART

PC shutdown: In case the LDX-U20 is used to supply a PC it is possible to automatically shut down the PC after an adjustable time of backup. For this the PC must run the POWERMASTER application (provided free) and must be connected through USB. Optionally POWERMASTER can call a task on the PC before shutting down, for example to backup some sensitive data.

Automatic restart: LDX-U20 is able to automatically restart a PC which was powered OFF by mistake, for example in case of the Operating System (OS) crash. The user may adjust an output current threshold and a timer used for detecting the PC OFF status. In order to restart the PC the LDX-U20 toggles the output OFF and then ON again. User must enable in the PC BIOS the automatic start in case of supply ON.

Note: The LDX-U20 cannot interrupt the supply flow from the input to the output. Therefore the user must use one of the LDX-U20 available relays (by activating the PC OFF signal on it) in order to enable automatic PC restart when the input supply is present. The relay contact (rated 2A/30Vdc) must be wired in series to the device output using a 4A fast cartridge fuse (Littlefuse 0217004.HXP or equivalent). Be careful to respect maximum current rating of the fuse.

In case the load (PC) current exceeds the LDX-U20 dry contact rating the use of an external relay with suitable current/voltage rating is needed, relay coil voltage shall match output voltage. It should be driven by the LDX-U20 internal dry contact.

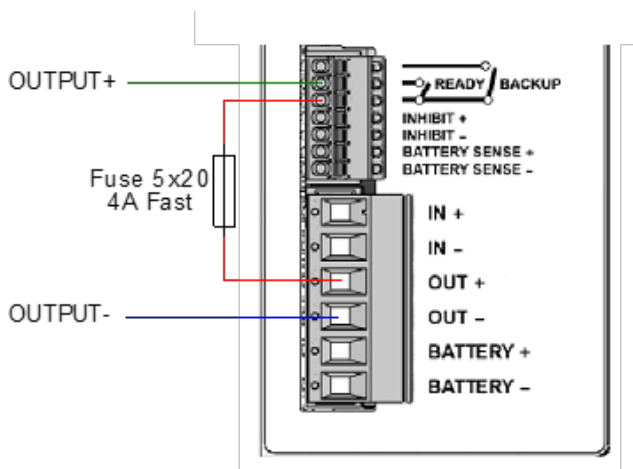

Figure 3. Internal relay

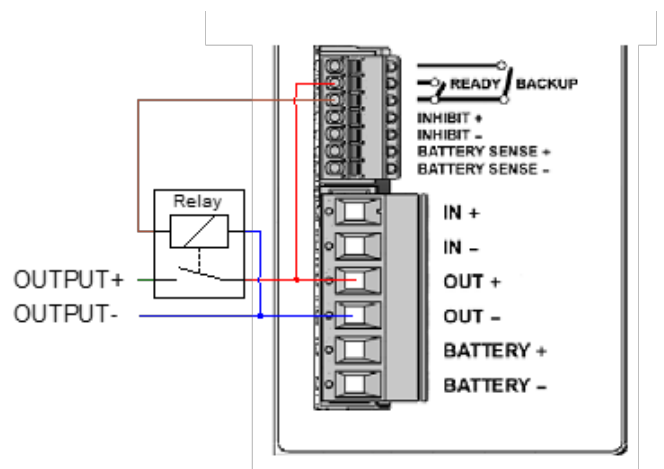

Figure 4. External relay

The diagram below shows the LDX-U20 behavior when Shutdown and automatic restart is enabled.

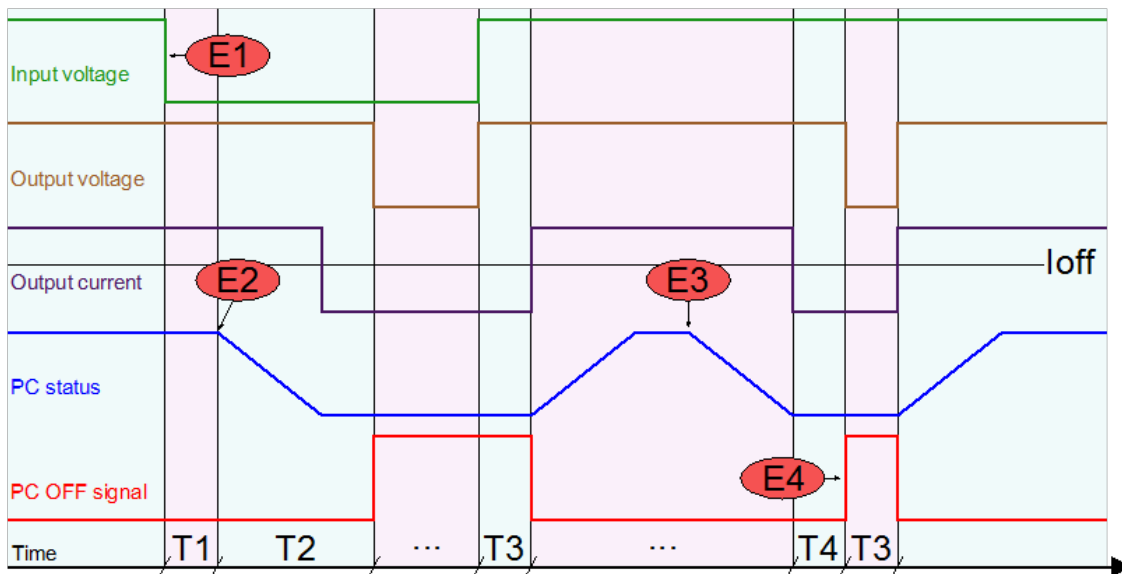

Figure 5. Shutdown and restart chart

PARAMETER	NAME	DESCRIPTION
E1	Backup	Power failure on the line happens. System enters backup mode.
E2	Automatic PC shutdown	The POWERMASTER sends a shutdown command to the PC. Optionally: a task is called before shutdown. This event is triggered by the "PC shutdown delay" (§5.2.23) or "Battery low alarm" (§5.2.8), whatever comes first.
E3	Unexpected PC shutdown	The PC shutdowns in an unexpected way, for example caused by OS crash.
E4	PC restart	LDX-U20 detect the PC being OFF because the output current was lower than loff current threshold for T4 time. As a consequence LDX-U20 generates an ON->OFF->ON cycle on its output.
T1	PC shutdown delay	User settable (§5.2.23). Time between start of backup and start of PC shutdown procedure.
T2	PC shutdown time	User settable (§5.2.24). Time between start of shutdown procedure and output voltage OFF. This time must be set longer than the maximum time the PC takes to complete the shutdown.
T3	PC restart minimum OFF time	User settable (§5.2.25). T3 is the delay used between the return of the input voltage and the activation of the output. The same time is used by the automatic restart function as power OFF time to restart the PC. The value must be big enough for the PC to detect the supply ON->OFF->ON cycle to restart.
T4	PC OFF detection timer	User settable (§5.2.27). Minimum time at which the output current must be below the loff current threshold to trigger the automatic PC restart (PC supply ON->OFF->ON cycle).
loff	PC OFF detection current threshold	User settable (§5.2.26). Current threshold used to detect PC OFF status. This value must be lower than the minimum PC current consumption when this is ON.

Table 2. Shutdown and restart

The parameters are settable through the LDX-U20 LCD or using the POWERMASTER application. The checkbox "Run on startup" must be checked on POWERMASTER when PC shutdown function is used, select "Start in tray" to start in minimized into the windows system tray. To inhibit the software from calling the shutdown command user can select the "Inhibit shutdown" check box.

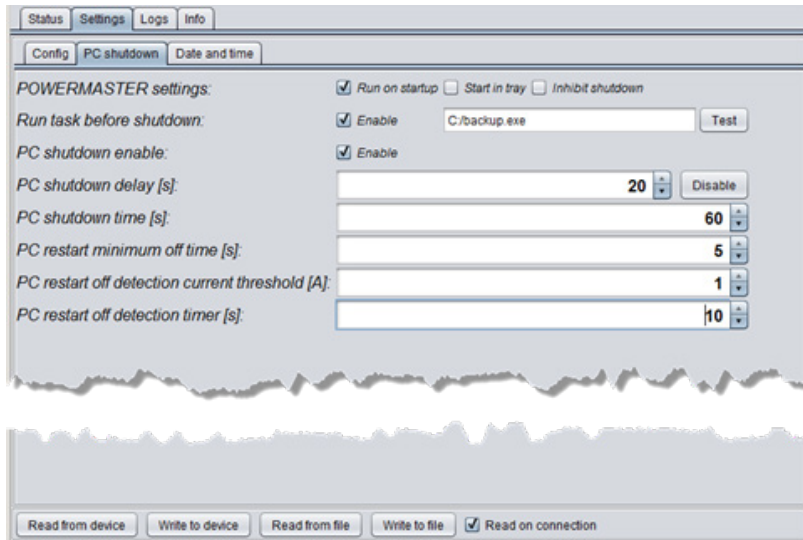

Figure 6. PC shutdown settings

3.4 BATTERY HEALTH MONITOR

The battery health monitor is composed of:

- Internal resistance (R_i) measurement: The resistance is periodically measured. The internal resistance is a good indicator of the battery health status; a sudden increase of the internal resistance indicates a potential problem on the battery or on the battery wiring (see §3.5).
- Temperature (T) measurement: The battery temperature is monitored through an optional temperature sensor (P/N: WNTC-2MT). The battery charger takes into account the battery temperature and provides a temperature compensated charging voltage. In case of over temperature the system disconnects the battery to prevent damage.
- Coulomb counter: It allows having a quick estimation of the remaining battery capacity and consequently the available backup time.
- Deep discharge protection: It protects against the deep discharge of the battery which can lead to its irreversible damage.

3.5 BATTERY RESISTANCE MEASUREMENT

The battery internal resistance (R_i) is measured by injecting a defined AC current through a constant current source (CCS) in the battery and measuring the AC voltage drop across the battery terminals. The principle is represented in Figure 7. The injected AC current $I(AC)$ is flowing also through the cables + connectors resistance - " R_{cables} ".

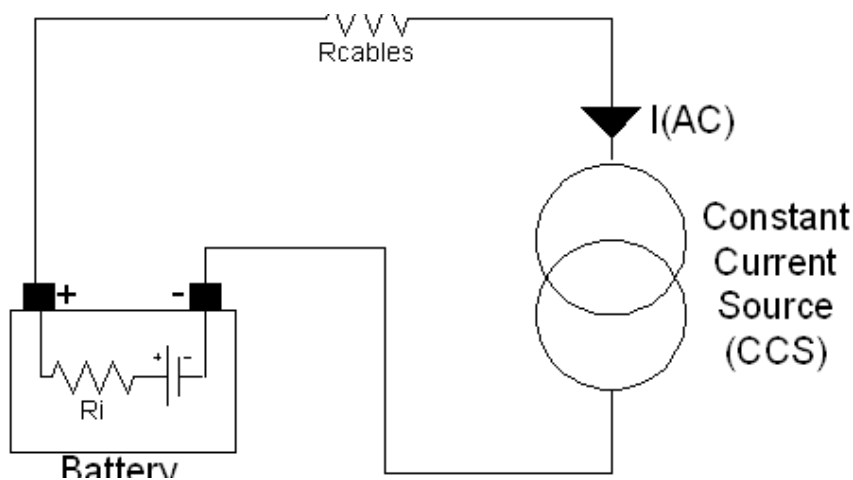

Figure 7. Internal resistance measurement

Without using the battery sense connection as shown in Figure 9 the AC voltage drop is measured across the battery connection terminals on the LDX-U20. The measured resistance will be in this case:
 $R_{measured} = R_i + R_{cables}$. When high Ah batteries and / or small and long cables are used R_{cables} can be $> R_i$. Anyhow a connection problem as for example a loose contact can be detected by this measurement method.

By using the battery sense connection (a “Kelvin” type connection) as shown in Figure 10 the AC voltage drop is measured directly at the battery terminal. In this case the measured resistance is exactly the battery internal resistance R_i , independently on the cables length and size.

It is recommended to use this method to have an accurate reading of the battery internal resistance and thus an accurate prediction of the battery health status.

If the battery sense cables length is $> 2m$ it is recommended to twist the 2 wires together in order to increase the noise immunity.

3.6 BATTERY CHARGER

The battery charger supports various chemistries such Lead-Acid, Nickel, Lithium and every other battery chemistry assuming that the charging voltage and charging current values are provided by the battery manufacturer. The charging algorithm is shown on Figure 8. Other charging algorithms can be implemented by request.

The user must set to the unit the following parameters to allow the charger to perform correctly:

- Battery chemistry: selectable between Lead-Acid, Nickel, Lithium (see §5.2.2).
- Battery nominal voltage: between 12V and 28V (see §5.2.3).
- Battery capacity: between 1.2Ah and 150Ah (see §5.2.4).
- Battery charging voltage: provided by the battery manufacturer (see §5.2.5).
- Battery charging current: provided by the battery manufacturer (see §5.2.6).
- Battery deep discharge voltage (see §5.2.7).

The battery charger automatically reduces the current to avoid exceeding the maximum input current (20A) in case of high current load. For example if the load is consuming 19A and the charger current is set to 3A, the charger current is automatically reduced to 1A to avoid the 20A input current limit.

The charger voltage is independent on the input voltage (power supply), and is user settable.

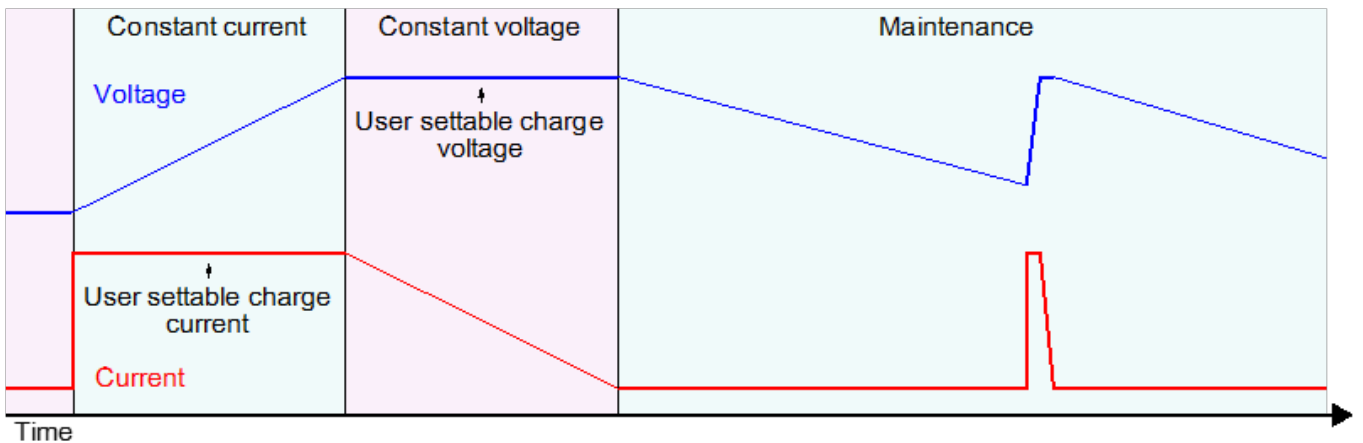

Figure 8. Battery charging algorithm

The battery charge terminates in case at least one of the following conditions are satisfied:

- **Low current:** The measured battery current is lower than 10% of the “Battery charge current”.
- **Timer:** the charge is terminated after the battery has been charged for a predetermined amount of time. The value is automatically calculated by the device.

For Nickel batteries only the following conditions are also checked:

- **Temperature Cutoff (TCO):** The battery temperature if higher than the “Battery maximal temperature” (§5.2.11) minus 3°C for more than one minute. For example if the maximal battery temperature is set to 60°C, the charge terminates in case the temperature is higher than 57°C.

- **Rate of Temperature Increase ($\Delta T/dt$):** The battery temperature is rising at a rate equal or superior then 1°C/min. To avoid unattended end of charge don't place the system on an ambient with rapid changes of temperature (for example exposed to direct sunlight).

Warning: In order to avoid potentially hazardous situations including fire hazard, safety recommendations must be followed. Only authorized staff can install the unit.

Warning: For Lithium cells the balancing and protection circuit must be included in the battery pack.

For nickel batteries the use of the external temperature sensor is mandatory. The sensor must be placed in contact with the battery.

3.7 COULOMB COUNTER

LDX-U20 measures the current flowing from/to the battery to keep track of the capacity available on the battery. The capacity is measured in Ampère Hours [Ah]. The value shown is based on the following assumptions:

- The value shown is just informative and does not represent the real state of charge of the battery in some circumstances, for example if the battery is damaged.
- When the battery is connected for the first time or the system starts from OFF, the system assumes the battery is fully discharged and start with 0Ah counter.
- For Lead acid batteries only, during battery charge an approximation of charge is done checking the battery voltage.
- Once the battery is fully charged the system sets the counter to the nominal capacity specified by the user (§5.2.4).

3.8 COLD START

The cold start is a procedure that allows turning ON the UPS without the input power. This procedure is used to turn ON the UPS to operate during a power interruption or to determine if the UPS will not turn ON due to a bad input power. This practice is also a method to see if the battery connected to the LDX-U20 is functional.

In cold start the DCU 20 will remain ON for at least 60 seconds independently from the battery voltage being under the deep discharge threshold, the inhibit input and the backup timer.

After the first 60 seconds the device stays ON until the battery is not deep discharged, the "Max backup timer" is not expired or the inhibit input is not active.

If the input supply returns during cold start the device reverts to normal operation.

To cold start the LDX-U20:

- Press and HOLD simultaneously the menu button and OK button until you see the welcome message on the screen. On the status screen the input voltage status is indicated as "COLDSTART".
- RELEASE the buttons.

4 INSTALLATION

Warning: In order to avoid potentially hazardous situations including fire hazard, safety recommendations must be followed. Only authorized staff can install the unit.

4.1 CONNECTING THE INPUT TO THE POWER SUPPLY

The LDX-U20 must be connected to a DC power supply rated between 12VDC and 28VDC with a maximum output current of 20A. Use only 60/75 Class I copper 1.5...2.5mm² wires stripped 6...7.5mm. The tightening torque must be 0.5...0.6Nm. Please respect the wiring polarity!

Note: The input current is equal to the load current plus the current needed by the battery charger to recharge the battery.

Caution: This input is designed to be connected **ONLY** to a short circuit protected power supply; connecting a battery to this input or other DC sources with not defined current limitation may seriously damage the unit or the load and even result in fire hazard.

4.2 CONNECTING THE LOAD

The LDX-U20 must be connected to a DC load rated between 12VDC and 28VDC / maximum 20A. Use only 60/75 Class I copper 1.5...2.5mm² wires stripped 6...7.5mm. The tightening torque must be 0.5...0.6Nm. Please respect the wiring polarity! Please check the load and the power supply are rating compliant.

4.3 CONNECTING THE BATTERY

The LDX-U20 must be connected to a battery with nominal voltage between 12VDC and 28VDC with up to 150Ah capacity. Higher capacity batteries can also be used at the expense of a longer charging time. Use only 60/75 Class I copper 1.5...2.5mm² wires stripped 6...7.5mm. The tightening torque must be 0.5...0.6Nm.

Caution: The battery shall be connected to the LDX-U20 through a 30A ATO fuse (or equivalent). Even is the unit is electronically protected against short circuit it is mandatory to use a fuse for safety reasons.

Please respect the wiring polarity!

Avoid keeping the LDX-U20 connected to the battery for long time when not used. Although the current consumption from the battery when the unit is OFF is very low (about 30μA) it can discharge the battery in the long time.

4.4 CONNECTING THE TEMPERATURE SENSOR

An optional temperature sensor (P/N: WNTC-2MT) can be connected to its input on the front panel. The temperature sensor is provided with 2m long cables and must be fixed to the battery body to measure its temperature (an adhesive pad can be used). When the sensor is connected the battery temperature is automatically displayed on the LCD and a temperature compensated charge is activated when charging Lead-Acid batteries.

4.5 CONNECTING THE INHIBIT INPUT

An opto-isolated digital input is provided. A digital signal between 5VDC and 30VDC must be applied to this input to enable the INHIBIT function. By default when the signal is 0V (or the INHIBIT input is not connected) the unit will switch the load to the battery as soon as the input voltage is no more present. Applying a signal to this input inhibits the backup function and the load can be switched OFF as soon as the input fails with no battery backup. The polarity of this input can be changed as explained in §5.2.15.

4.6 DRY CONTACTS

2 relays' dry contacts are provided on the LDX-U20. Connect the 2 relays dry contact using 60/75 Class I copper 0.15...0.5mm² wires stripped 7...8mm. The connector is provided with spring terminals.

Note: the 2 relays contacts have one pole in common.

4.7 BATTERY SENSE CONNECTION

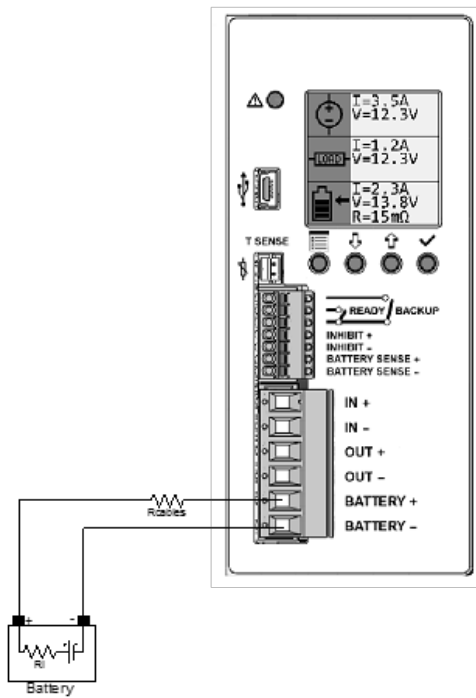

Figure 9. Battery connection without sense

The battery sense connection is optional and it is recommended to use it to have an accurate measurement of the battery internal resistance (see §3.5).

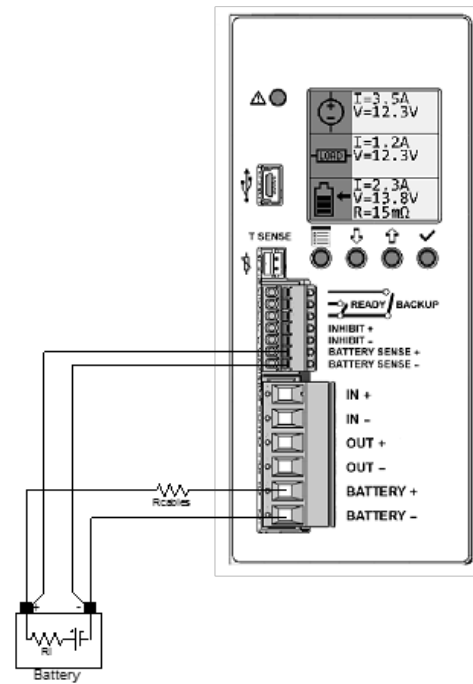

Figure 10. Battery connection with sense

Caution: please respect the polarity of the battery sense connection!

5 USER INTERFACE

Power ON screen:

This screen is shown at power ON. It shows the device name, serial number and firmware version.

Status:

This is the default view where the user can find the most relevant information about the device status. The system always falls back to this view after 60s of inactivity (no key pressed).

Settings:

All the device settings are configurable from this menu. Use the UP/DOWN KEY to navigate through the parameters. Press the OK KEY to enter/exit the editing mode. In editing mode use the UP/DOWN KEY to change the highlighted value.

Info:

Device information such as firmware version, serial number and device name is visible from this menu.

Logs:

All the alarms and event are logged in a circular buffer and visible from this screen. Use the UP/DOWN KEY to navigate through the logs.

Wizard:

The wizard helps the user to configure the system through a series of screens.

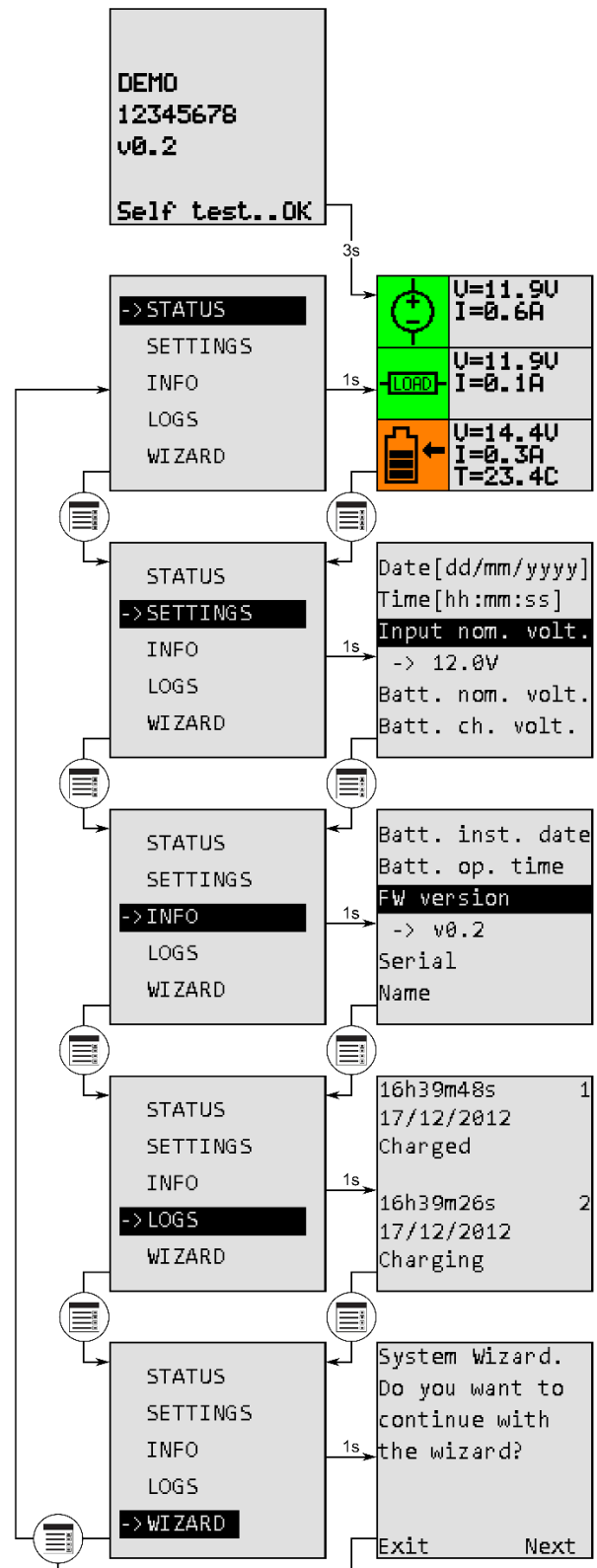

Table 3. User interface layout





SYMBOL	NAME	FUNCTION
	MENU KEY	Scrolls between menus.
	DOWN KEY	Scrolls down menus and values.
	UP KEY	Scrolls up menus and values.
	OK KEY	Confirms selection.

Table 4. User interface keys

The GUI is composed of 5 main menus which are selectable using the MENU KEY as shown on Table 3. The description of each menu is given below.

5.1 STATUS

The status screen shows the measurement and statuses to ease the system diagnostic. The screen is divided in three main sections identified by the symbols shown below:



	Input: The measured input voltage and current is shown in this section. In case of problems with the input the background color of the symbol changes from green to red. A message with the cause appears.
	Output: The measured output voltage and current is shown in this section. In case of problems with the output the background color of the symbol changes from green to red and a message with the cause appears.
	Battery: The battery voltage, current, temperature, resistance and charge are shown in this section. In case of problems with the battery the background color of the symbol changes from green to red and a message with the cause appears. During charging and discharging the symbol background color changes to orange and the number of bars drawn inside reflects the charge status. During discharging and charging an arrow drawn beside the symbol reflects the direction of the current flowing through the battery, pointing towards the battery during charging.

Table 5. Status screen symbols

Furthermore in case of problem a full screen alarm message appears on the screen after 1min of inactivity (no key pressed). The message can be removed pressing the MENU KEY.

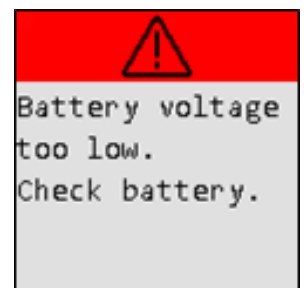

5.2 SETTINGS

The setting menu contains all the configurable parameters available to the user. Use the UP/DOWN KEY to navigate through the menu items. Press the OK KEY to enter and exit the editing mode, while in editing mode use the UP/DOWN KEY to change the selected value.

5.2.1 INPUT NOMINAL VOLTAGE

Used to set the nominal input voltage on the input connector. Used to generate the input under voltage and over voltage alarm. See §6 for more details.

Default: 24V
Range: 11V ... 28V
Resolution: 0.1V

```
Relay 1 (ready)
Relay 2 (backup)
Input nom. volt.
-> 24.0V
Batt. chemistry
Batt. nom. volt.
```

5.2.2 BATTERY CHEMISTRY

Used to set the chemistry of the battery. The system support Lead Acid, Nickel and Lithium batteries. For Lithium the battery pack used must include the protection and balancing circuitry.

Default: Pb
Choices: Pb, NiMh (CC/CV), Lith.(CC/CV)

```
Relay 2 (backup)
Input nom. volt.
Batt. chemistry
-> Pb
Batt. nom. volt.
Batt. capacity
```

5.2.3 BATTERY NOMINAL VOLTAGE

Used to set the nominal battery voltage.

Default: 24V
Range: 11V ... 28V or input nominal voltage +20%
Resolution: 0.1V

```
Input nom. volt.
Batt. chemistry
Batt. nom. volt.
-> 24.0V
Batt. capacity
Batt. ch. volt.
```

5.2.4 BATTERY CAPACITY

Used to set the nominal battery capacity of the battery. The internal Coulomb counter uses this value to indicate the state of charge of the battery.

Default: 2Ah
Range: 1.2Ah ... 150Ah
Resolution: 0.1Ah

```
Batt. chemistry
Batt. nom. volt.
Batt. capacity
-> 2.0Ah
Batt. ch. volt.
Batt. ch. curr.
```

5.2.5 BATTERY CHARGE VOLTAGE

Used to set the maximum voltage used to charge the battery. See §3.6 for more details.

Default: 28.8V
Range: battery nominal voltage ... 33V or battery nominal voltage +40%
Resolution: 0.1V

```
Batt. nom. volt.
Batt. capacity
Batt. ch. volt.
-> 28.8V
Batt. ch. curr.
Batt. deepdisch.
```

5.2.6 BATTERY CHARGE CURRENT

Used to set the maximum current used to charge the battery. See §3.6 for more details.

Default: 0.2A
Range: 0.2A ... 5A
Resolution: 0.1A

```
Batt. capacity
Batt. ch. volt.
Batt. ch. curr.
-> 0.2A
Batt. deepdisch.
Batt. nom. Ri
```

5.2.7 BATTERY DEEP DISCHARGE VOLTAGE

Used to set the deep discharge voltage of the battery. If the measured battery voltage drops below this value the system disconnects it in order to prevent irreversible damage.

Default: 18V

Range: 8.2V ... battery nominal voltage -25%

Resolution: 0.1V

```
Batt. ch. volt.
Batt. ch. curr.
Batt. deepdisch.
-> 18.0V
Batt. nom. Ri
Batt. max temp.
```

5.2.8 BATTERY LOW VOLTAGE

An alarm is generated if during discharge the battery voltage drops below this threshold.

Default: 18V

Range: battery deep discharge voltage ... 28V

Resolution: 0.1V

```
Batt. ch. curr.
Batt. deepdisch.
Batt. low volt.
-> 22.0V
Batt. nom. Ri
Batt. max Ri var
```

5.2.9 BATTERY NOMINAL INTERNAL RESISTANCE

Used to set the nominal battery internal resistance of the battery. When set to automatic the system will record the next valid measurement as the nominal value. When set to disabled no alarm related to the battery internal resistance will be generated.

Default: Disabled

Range: 1mΩ ... 300mΩ, Disabled, Automatic

Resolution: 1mΩ

```
Batt. ch. curr.
Batt. deepdisch.
Batt. nom. Ri
-> Disabled
Batt. max temp.
Batt. lifetime
```

5.2.10 BATTERY MAXIMAL INTERNAL RESISTANCE VARIATION

Combined with the nominal internal resistance, it defines the threshold for the ALARM_BATTERY_RI_TOO_HIGH.

Default: 200%

Range: 20% ... 300%

Resolution: 1%

```
Batt. deepdisch.
Batt. nom. Ri
Batt. max Ri var
-> 50
Batt. max temp.
Batt. lifetime
```

5.2.11 BATTERY MAXIMUM TEMPERATURE

An optional external temperature sensor (P/N: WNTC-2MT) is required. Used to set the maximum temperature at which the battery can operate safely. If the measured temperature exceeds the set value, an alarm is generated and the battery charging is stopped until the return under normal temperature level.

Default: 50°C

Range: 30°C ... 80°C

Resolution: 1°C

```
Batt. chemistry
Batt. nom. Ri
Batt. max temp.
-> 50C
Batt. lifetime
Max backup time
```

5.2.12 BATTERY MINIMUM TEMPERATURE

An optional external temperature sensor (P/N: WNTC-2MT) is required. Used to set the minimum temperature at which the battery can operate safely. If the measured temperature is lower than the set value, an alarm is generated and the battery charging is stopped until the return under normal temperature level.

Default: -10°C

Range: -20°C ... 0°C

Resolution: 1°C

```
Batt. deepdisch.
Batt. nom. Ri
Batt. min temp.
-> -10C
Batt. lifetime
Max backup time
```

5.2.13 BATTERY LIFETIME

Used to set the expected battery lifetime. Once the battery operating time exceeds the set value an alarm is generated.

Default: 100kh

Range: 1kh ... 200kh

Resolution: 1kh

```
Batt. nom. Ri
Batt. max temp.
Batt. lifetime
-> 100kh
Max backup time
Inhibit polarity
```

5.2.14 MAXIMUM BACKUP TIME

Used to set the maximum time the system stays in backup before switching OFF. If disabled the system stays in backup until the battery reaches the deep discharge voltage.

Default: 2h

Range: 10s ... 2h, No timeout

Resolution: 1s

```
Batt. max temp.
Batt. lifetime
Max backup time
-> 2h:0m:0s
Inhibit polarity
Screen contrast
```

5.2.15 INHIBIT POLARITY

Used to select the polarity of the INHIBIT input. The inhibit input prevents the system to enter the backup mode.

Default: High

Choices: Low, High

```
Batt. lifetime
Max backup time
Inhibit polarity
-> High
Screen contrast
Screen backlight
```

5.2.16 SCREEN CONTRAST

Used to set the LCD screen contrast.

Default: 24

Range: 0 ... 40

Resolution: 1

```
Max backup time
Inhibit polarity
Screen contrast
-> 24
Screen backlight
Screen timeout
```

5.2.17 SCREEN BACKLIGHT

Used to set the LCD screen backlight.

Default: 2

Range: 1... 10

Resolution: 1

```
Inhibit polarity
Screen contrast
Screen backlight
-> 2
Screen timeout
Buzzer state
```

5.2.18 SCREEN TIMEOUT

To save the LCD backlight the system dims the LCD after the defined timeout value.

Default: 5min

Range: 1min ... 30min, Disabled

Resolution: 1min

```
Screen contrast
Screen backlight
Screen timeout
-> 5min
Buzzer state
Date[dd/mm/yyyy]
```

5.2.19 BUZZER STATE

Used to enable or disable the internal acoustic alarm buzzer.

Default: Enabled

Choices: Enabled, Disabled

```
Screen backlight
Screen timeout
Buzzer state
-> Enabled
Date[dd/mm/yyyy]
Time[hh:mm:ss]
```

5.2.20 DATE

Used to show and set the current RTC (Real Time Clock) date. The RTC is used to time stamp the event logs.

```
Screen timeout
Buzzer state
Date[dd/mm/yyyy]
-> 04/06/2014
Time[hh:mm:ss]
Relay 1 (ready)
```

5.2.21 TIME

Used to show and set the current RTC time. The RTC is used to time stamp the event logs.

```
Buzzer state
Date[dd/mm/yyyy]
Time[hh:mm:ss]
-> 13:42:03
Relay 1 (ready)
Relay 2 (backup)
```

5.2.22 PC SHUTDOWN ENABLE

Enables the PC shutdown function as explained in §3.3.

Default: Disabled

Choices: Enabled, Disabled

```
Date[dd/mm/yyyy]
Time[hh:mm:ss]
PC shut. enable
-> Enabled
PC shut. delay
PC shut. time
```

5.2.23 PC SHUTDOWN DELAY

Delay between start of backup and PC shutdown command sent by POWERMASTER, see §3.3 for details.

Default: 0s

Range: 0s ... 60min

Resolution: 1s

```
Time[hh:mm:ss]
PC shut. enable
PC shut. delay
-> 0m:5s
PC shut. time
PC rest. off T
```

5.2.24 PC SHUTDOWN TIME

Delay between start of PC shutdown and output power OFF, see §3.3 for details.

Default: 0s

Range: 0s ... 10min

Resolution: 1s

```
PC shut. enable
PC shut. delay
PC shut. time
-> 0m:5s
PC rest. off T
PC off det. I
```

5.2.25 PC RESTART MINIMUM OFF TIME

Minimum OFF time for PC restart, see §3.3 for details. When set to 0 the PC restart function is disabled.

Default: 0s

Range: 0s ... 60s

Resolution: 1s

```
PC shut. delay
PC shut. time
PC rest. off T
-> 0m:0s
PC off det. I
PC off det. T
```

5.2.26 PC OFF DETECTION CURRENT THRESHOLD

Current threshold for PC OFF detection, see §3.3 for details. When set to 0 the PC restart function is disabled.

Default: 0A

Range: 0A ... 20A

Resolution: 0.1A

```
PC shut. time
PC rest. off T
PC off det. I
-> 1.5A
PC off det. T
Relay 1 (ready)
```

5.2.27 PC OFF DETECTION TIMER

Timer user for PC OFF detection, see §3.3 for details.

Default: 1s

Range: 1s ... 60s

Resolution: 1s

```
PC rest. off T
PC off det. I
PC off det. T
-> 0m:12s
Relay 1 (ready)
Relay 2 (backup)
```

5.2.28 RELAY 1 (READY)

Used to configure the behavior of the Relay 1 contact. Click OK and then follow the instruction on the screen to define the polarity and event associated with the relay. See §3.1.3 for more details.

```
Date[dd/mm/yyyy]
Time[hh:mm:ss]
Relay 1 (ready)
-> Configure
Relay 2 (backup)
Input nom. volt.
```

5.2.29 RELAY 2 (BACKUP)

Used to configure the behavior of the Relay 2 contact. Click OK and then follow the instruction on the screen to define the polarity and event associated with the relay. See §3.1.3 for more details.

```
Time[hh:mm:ss]
Relay 1 (ready)
Relay 2 (backup)
-> Configure
Input nom. volt.
Batt. chemistry
```

5.3 INFO

While in the info menu, use the UP/DOWN KEY to navigate through the menu items.

5.3.1 FIRMWARE VERSION

Shows the current firmware version. Using the freely available POWERMASTER software is possible to upgrade the firmware with the latest available version.

```
Batt. inst. date
Batt. op. time
FW version
-> v1.0
Serial
Name
```

5.3.2 SERIAL

Shows the device serial number (S/N). This serial number corresponds to the S/N shown on the device label.

```
Batt. op. time
FW version
Serial
-> Serial
Name
Boot cycles
```

5.3.3 NAME

Shows the device name. Using the freely available POWERMASTER software is possible to modify the device name. The default name is DCU-20.

```
FW version
Serial
Name
-> Name
Boot cycles
Op. time
```

5.3.4 POWER ON CYCLES COUNTER

Shows the Power ON cycles counter, which is incremented by 1 every time the device is powered ON.

```
Serial
Name
Boot cycles
-> 3cycles
Op. time
Batt. inst. date
```

5.3.5 OPERATING TIME

Shows the device operating time. The counter shows the hours of operation (device powered) since the manufacturing.

```
Name
Boot cycles
Op. time
-> 0h
Batt. inst. date
Batt. op. time
```

5.3.6 BATTERY INSTALLATION DATE

Shows the battery installation date. This value can be edited pressing the OK KEY or using the wizard (see §5.5). It is used by the system to calculate the battery operating time.

```
Boot cycles
Op. time
Batt. inst. date
-> 19/12/2012
Batt. op. time
FW version
```

5.3.7 BATTERY OPERATING TIME

Shows the current battery operating time. The value is calculated from the date entered in the battery installation date field. Once the operating time exceeds the defined battery lifetime (see 5.2.13) an alarm is generated (see §6).

```
Op. time
Batt. inst. date
Batt. op. time
-> 0h
FW version
Serial
```

5.4 LOGS

Every event is logged in the device FLASH memory. From the log menu the user can view their history. Use the UP/DOWN KEYS to navigate between logs.

For each event the following information is given:

Timestamp: The time and date at which the event happened.

Event name: The name identifying the event, see §6 for the complete list of events

Value: The value may be empty. See §6 for the detailed description of this field for each event.

```
16h04m19s 1
19/12/2012
Charging
16h04m19s 2
19/12/2012
IUVE 2.22V
```

5.5 WIZARD

The wizard assists the user during the LDX-U20 configuration. The wizard should be run once at commissioning and every time the battery is replaced. The wizard shows the following screens:

1) The user must confirm with the OK KEY or use the MENU KEY to exit the wizard. Exiting the wizard any time before the end leaves the configuration unchanged.

```
System Wizard.
Do you want to
continue with
the wizard?
Exit Next
```

2) Insert the input nominal voltage and click next to confirm. See §5.2.1 for more details.

```
Select nominal
input voltage:
VinNom=12.0V
Exit Next
```

3) Insert the battery chemistry and click next to confirm. See §5.2.2 for more details.

```
Select battery
chemistry:
Ch=Pb
Exit Next
```

4) Insert the battery nominal voltage and click next to confirm. See §5.2.3 for more details.

```
Select nominal
battery voltage:
UbatNom=12.0V
Exit Next
```

5) Insert the battery nominal capacity and click next to confirm. See §5.2.4 for more details.

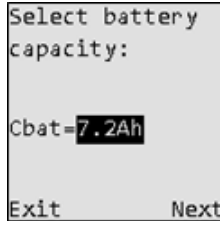

6) Insert the battery charge voltage and click next to continue. See §5.2.5 for more details.

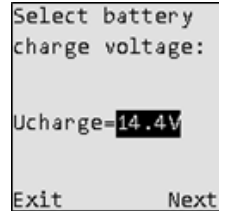

7) Insert the battery charge current and click next to confirm. See §5.2.6 for more details.

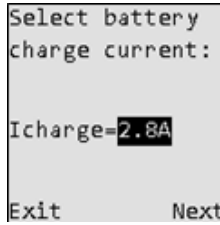

8) Insert the battery deep discharge protection voltage and click next to confirm. See §5.2.7 for more details.



9) Insert the battery nominal internal resistance and click next to confirm. See §5.2.9 for more details.

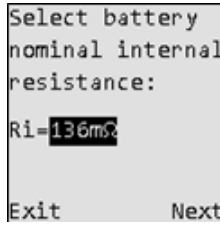

10) Insert the battery maximum temperature and click next to confirm. See §5.2.11 for more details.

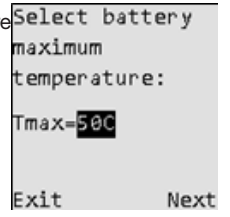

11) Insert the battery expected lifetime and click next to confirm. See §5.2.13 for more details.

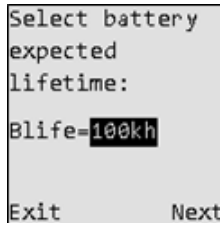

12) Insert the battery installation date and click next to confirm. See §5.3.6 for more details.

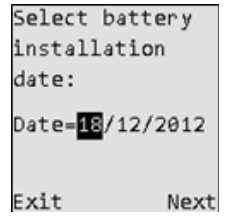

12) The wizard is finished. Click the OK KEY to start using the new values in the configuration or the MENU KEY to exit discarding the data and keep using the old configuration.

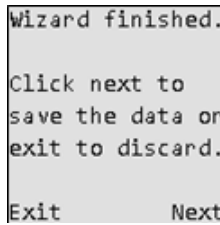

6 EVENTS AND ALARMS

NAME	SHORT NAME	VALUE
EVENT_POWER_ON	Power ON	Power ON cycles count.
Description		
Triggered at device power ON.		
NAME	SHORT NAME	VALUE
EVENT_POWER_OFF	Power OFF	None.
Description		
Triggered when LDX-U20 powers OFF.		
NAME	SHORT NAME	VALUE
EVENT_BATTERY_CHARGING	Charging	None.
Description		
Triggered when the LDX-U20 starts charging the battery.		

NAME	SHORT NAME	VALUE
EVENT_BATTERY_CHARGED	Charged	None.

Description
Triggered when the LDX-U20 finishes charging the battery. The battery is fully charged.

NAME	SHORT NAME	VALUE
EVENT_BATTERY_DISCHARGING	Discharging	None.

Description
Triggered when the LDX-U20 enters the backup mode.

NAME	SHORT NAME	VALUE
EVENT_INHIBIT_START	Inhibit start	None.

Description
Triggered when the inhibit input toggles from false to true.

NAME	SHORT NAME	VALUE
EVENT_INHIBIT_END	Inhibit end	None.

Description
Triggered when the inhibit signal toggles from true to false.

NAME	SHORT NAME	VALUE
ALARM_INPUT_UNDERVOLT_START	IUVS	Threshold voltage triggering the alarm.

Description
The measured input voltage is lower than the alarm threshold. The threshold is calculated taking the lowest value between the input nominal voltage (§5.2.1) and the battery nominal voltage (§5.2.3) -10%.

NAME	SHORT NAME	VALUE
ALARM_INPUT_UNDERVOLT_END	IUVE	The minimum input voltage reached during the alarm.

Description
The measured input voltage returns above the alarm threshold.

NAME	SHORT NAME	VALUE
ALARM_INPUT_OVERVOLT_START	IOVS	Threshold voltage triggering the alarm.

Description
The measured input voltage exceeds the alarm threshold. The threshold is the input nominal voltage (§5.2.1) +30%.

NAME	SHORT NAME	VALUE
ALARM_INPUT_OVERVOLT_END	IOVE	The maximum input voltage reached during the alarm.

Description
The measured input voltage returns below the alarm threshold.

NAME	SHORT NAME	VALUE
ALARM_INPUT_OVERLOAD_START	IOLS	Threshold current triggering the alarm.

Description
The measured input current exceeds the alarm threshold. The alarm threshold is set to 22A.

NAME	SHORT NAME	VALUE
ALARM_INPUT_OVERLOAD_END	IOLE	The maximum input current reached during the alarm.

Description
The measured input current returns below the alarm threshold.

NAME	SHORT NAME	VALUE
ALARM_OUTPUT_OVERLOAD_START	OOLS	Threshold current triggering the alarm.
Description		
The measured output current exceeds the alarm threshold. The alarm threshold is set to 22A.		
NAME	SHORT NAME	VALUE
ALARM_OUTPUT_OVERLOAD_END	OOLE	The maximum output current reached during the alarm.
Description		
The measured output current returns below the alarm threshold.		
NAME	SHORT NAME	VALUE
ALARM_BATTERY_UNDERVOLT_START	BUVS	Threshold voltage triggering the alarm.
Description		
The measured battery voltage is lower than the alarm threshold. The threshold is 80% of the battery deep discharge voltage (§5.2.7).		
NAME	SHORT NAME	VALUE
ALARM_BATTERY_UNDERVOLT_END	BUVE	The minimum battery voltage reached during the alarm.
Description		
The measured battery voltage returns above the alarm threshold.		
NAME	SHORT NAME	VALUE
ALARM_BATTERY_LOW_START	BLOWS	Threshold voltage triggering the alarm.
Description		
During discharge the measured battery voltage is lower than the battery low voltage threshold (§5.2.8).		
NAME	SHORT NAME	VALUE
ALARM_BATTERY_LOW_END	BLOWE	The minimum battery voltage reached during the alarm.
Description		
The measured battery voltage returns above the battery low voltage threshold (§5.2.8).		
NAME	SHORT NAME	VALUE
ALARM_BATTERY_OVERVOLT_START	BOVS	Threshold voltage triggering the alarm.
Description		
The measured battery voltage exceeds the alarm threshold. The threshold is the battery charge voltage (§5.2.5) + 10%.		
NAME	SHORT NAME	VALUE
ALARM_BATTERY_OVERVOLT_END	BOVE	The maximum battery voltage reached during the alarm.
Description		
The measured battery voltage returns below the alarm threshold.		
NAME	SHORT NAME	VALUE
ALARM_BATTERY_OVERTEMP_START	BOTS	Threshold temperature triggering the alarm.
Description		
The measured battery temperature exceeds the alarm threshold. The threshold is the battery maximum temperature (§5.2.11).		
NAME	SHORT NAME	VALUE
ALARM_BATTERY_OVERTEMP_END	BOTE	The maximum battery temperature reached during the alarm.
Description		
The measured battery temperature returns below the alarm threshold.		

NAME	SHORT NAME	VALUE
ALARM_BATTERY_UNDERTEMP_START	BUTS	Threshold temperature triggering the alarm.
Description		
The measured battery temperature is lower than the alarm threshold. The threshold is the battery minimum temperature (§5.2.12).		
NAME	SHORT NAME	VALUE
ALARM_BATTERY_UNDERTEMP_END	BUTE	The minimum battery temperature reached during the alarm.
Description		
The measured battery temperature returns above the alarm threshold.		
NAME	SHORT NAME	VALUE
ALARM_BATTERY_RI_TOO_HIGH_START	Ri high start	None.
Description		
The measured battery internal resistance exceeds the alarm threshold. The threshold is the battery nominal internal resistance (§5.2.9) + maximal internal resistance variation (§5.2.10).		
NAME	SHORT NAME	VALUE
ALARM_BATTERY_RI_TOO_HIGH_END	Ri high end	None.
Description		
The measured battery internal resistance returns below the alarm threshold.		
NAME	SHORT NAME	VALUE
ALARM_SHORT_CIRCUIT	Short circ.	None.
Description		
A short circuit has been detected on the output.		
NAME	SHORT NAME	VALUE
ALARM_BATTERY_ERROR	Batt. error	None.
Description		
The LDX-U20 was unable to charge the battery correctly.		

7 PHYSICAL DIMENSIONS

